

Einzelteilübersicht / Spare parts list / Liste des pièces détachées / Onderdelenoverzicht / Lista da peças / Resumo de peça individual	2
Montagehilfen und Hinweise / Assembly aids and instructions / Aides de montage et instructions / Montagehulpmiddelen en aanwijzingen / Ayudas de montaje e instrucciones / Montagens e indicações	3
Software und Interface / Software and interface / Logiciel et interface / Software en interface / Software e interface / Software e Interface	5
Interessante Infos / Interesting information / Infos interessantes / Interessante informatie / Información interesante / Informações interessantes	5

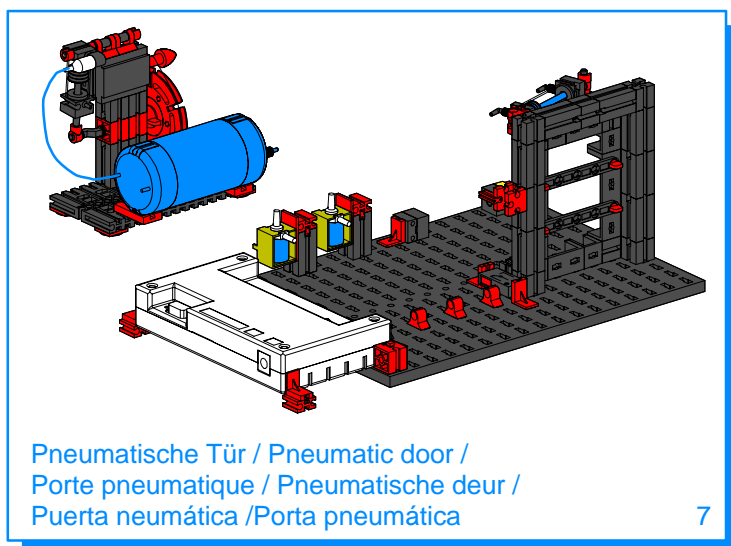

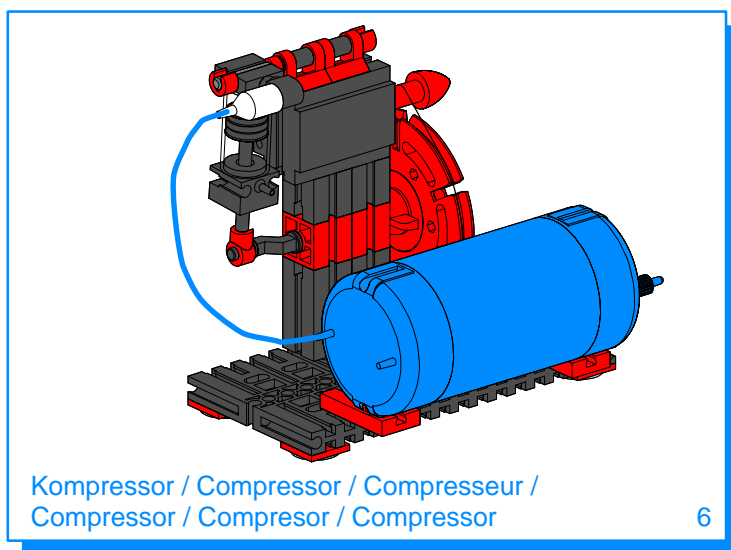
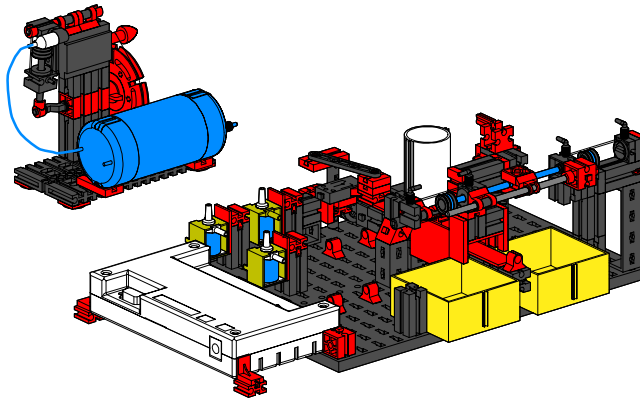

Sortieranlage / Sorting machine /
 Installation de triage / Sorteereinrichtung /
 Instalación clasificadora / Equipamento de seleção

11

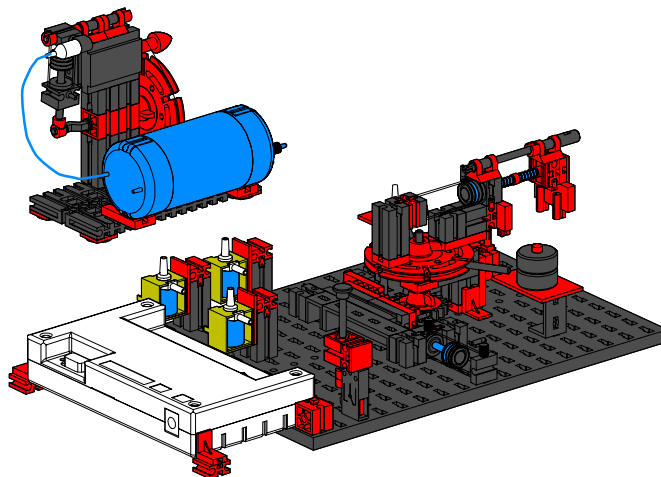

Greifer / Gripper / Manipulateur /
 Grijptang / Brazo transportador / Pegador



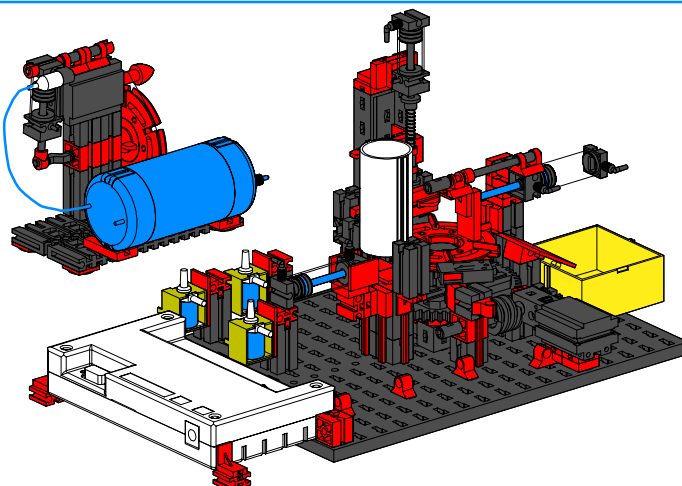







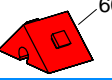
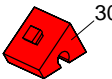



16

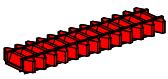
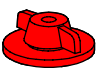

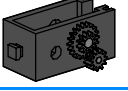
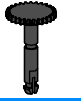



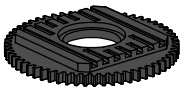
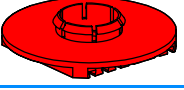







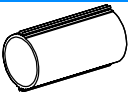

Bearbeitungszentrum / Processing centre /
 Centre d'usinage / Werkingscentrale /
 Centro de mecanización / Centro de trabalho

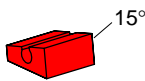
20



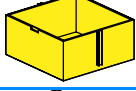
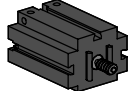
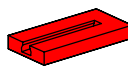

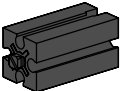







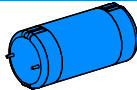

Einzelteilübersicht
Spare parts list
Liste des pièces détachées

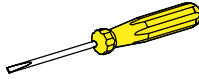
	31010
	4x
	31011
	2x
	31019
	2x
	31021
	1x
	31032
	1x
	31033
	1x
	31036
	1x
	31053
	1x
	31058
	3x
	31060
	17x
	31061
	5x
	31078
	1x
	31082
	1x
	31336
	13x
	31337
	13x
	31360
	1x
	31390
	1x
	31391
	1x
	31422
	2x

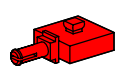
	31426
	4x
	31436
	9x
	31597
	3x
	31602
	2x
	31642
	4x
	31663
	1x
	31690
	1x
	31708
	2x
	31848
	2x
	31981
	2x
	31982
	16x
	32064
	6x
	32071
	1x
	32076
	2x
	32293
	2x
	32330
	2x
	32455
	2x
	32850
	2x
	32879
	15x

Onderdelenoverzicht
Lista da piezas
Resumo de peça individual

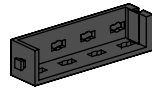
	32881
	11x
	32882
	3x
	32985
	1x
	33582
	4x
	34994
	5x
	35031
	3x
	35049
	7x
	35063
	1x
	35072
	1x
	35073
	2x
	35087
	1x
	35129
	1x
	35327
	3x
	35328
	6x
	35945
	1x
	35969
	15x
	35970
	1x
	35979
	1x
	36132
	2x

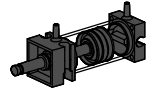
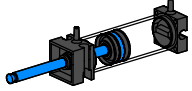
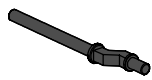
	36134
	1x
	36147
	2x
	36190
	1x
	36227
	1x
	36323
	4x
	36334
	1x
	36443
	1x
	36532
	2x
	36574
	5x
	36586
	1x
	36819
	6x
	36913
	1x
	36915
	10x
	36920
	2x
	36921
	4x
	36922
	4x
	36937
	2x
	36938
	2x
	36949
	1x

	36950 6x
	36952 2x
	36970 1x
	36981 1x
	37003 1x
	37034 1x
	37237 17x

	37238 9x
	37468 9x
	37636 2x
	37679 6x
	37681 1x
	37783 1x
	37869 1x

	37875 1x
	38216 2x
	38241 4x
	38244 1x
	38246 5x
	38248 2x
	38261 1x

	38414 2x
	38416 1x
	38423 10x
	38428 4x

Montagehilfen und Hinweise
Assembly aids and instructions
Aides de montage et instructions

Montagehulpmiddelen en aanwijzingen
Ayudas de montaje e instrucciones
Montagens e indicações

3/2-Wege-Magnetventil
 3/2-way solenoid valve
 Electrovanne à 3/2-voies

3/2-weg-magneetklep
 Válvula de electroimán de paso de 3/2
 Válvula magnética de 3/2 vias

1

2

3

4

5

6

9 V DC / 130 mA

1

2

6x

1

2

3x

7,5°

15°

30°

60°

1

2